

# Poly-V Sheaves

**B4**

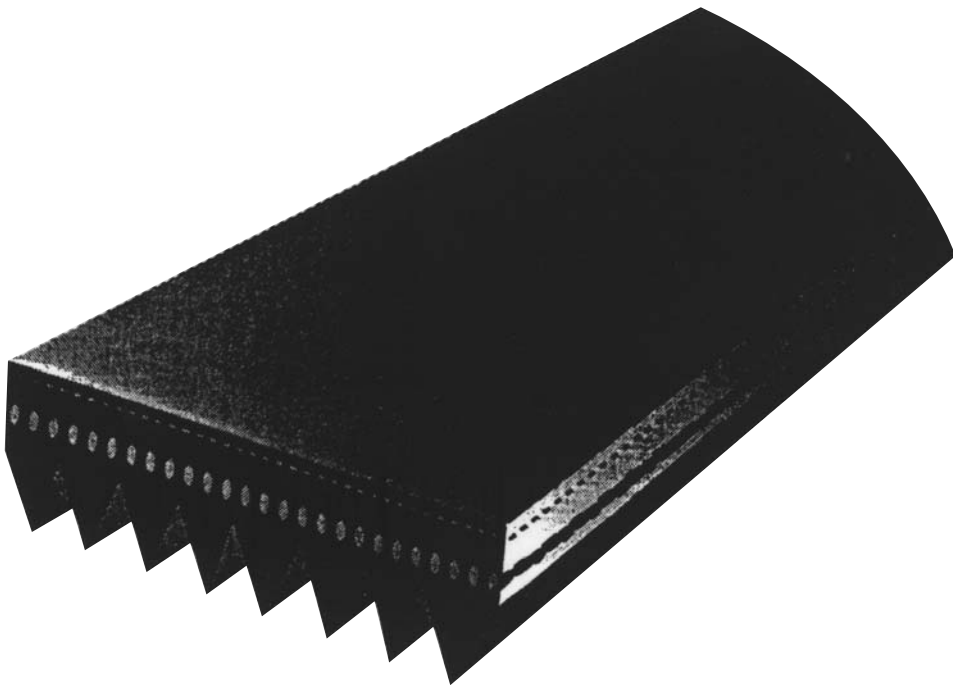

- **Provide a True Clamp Fit**
- **Are Easy to Install and Remove**
- **Permit Four-Way Mounting**

# BTS Stock Poly-V Sheaves J

## Dimensions

The Sheaves Below Are All Stock Sizes

### DIMENSION (In Inches)

Product No.	6 GROOVES				F = 23/32 BTS PARTS					Wt. Lbs.
	P.D.	O.D.	L	H	Bores					
					1/2*	5/8	3/4	7/8	1	
6J150	1.53	1.50	1 3/16	—		X	X		X	0.5
6J160	1.63	1.60	1 3/16	1.60	X	X	X			0.6
6J170	1.73	1.70	1 3/16	1.70	X					0.7
6J180	1.83	1.80	1 3/16	1.80	X	X	X			0.7
6J190	1.93	1.90	1 3/16	1.90	X	X	X	X		0.7

\* No Keyseat

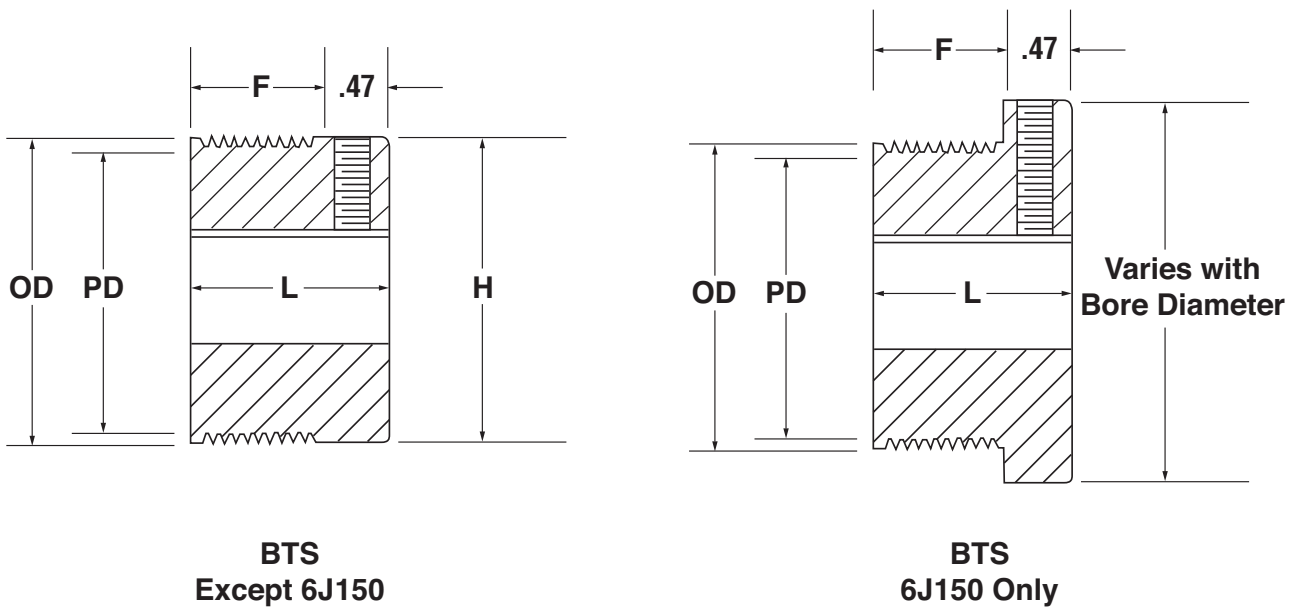

# Stock Poly-V Sheaves J

## Dimensions

The Sheaves Below Are All Stock Sizes

The dimensions given are with the Sure-Grip bushings in place. The figures following the letter in the "Type" column indicates the sheave construction: 1 - Solid; 2 - Web; 3 - Arms.

O.D.	P.D.	PRODUCT NO.	6 GROOVES						Wt. (lbs.)	PRODUCT NO.	10 GROOVES						Wt. (lbs.)
			F = 11/16								F = 1-3/32						
			E*	TYPE	BUSH	K	L	M			E*	TYPE	BUSH	K	L	M	
2.00	2.03	6J200	7/8	E1	JA	19/32	1	1 1/8	1.0	10J200	1 1/4	E1	JA	19/32	1	1 1/8	1.1
2.12	2.15	6J212	7/8	E1	JA	19/32	1	1 1/8	1.1	10J212	1 1/4	E1	JA	19/32	1	1 1/8	1.3
2.24	2.27	6J224	9/16	D1	JA	0	1	1/4	0.8	10J224	5/8	E1	JA	0	1	1/2	1.1
2.36	2.39	6J236	9/16	D1	JA	0	1	1/4	0.9	10J236	5/8	E1	JA	0	1	1/2	1.1
2.50	2.53	6J250	7/16	D1	JA	1/8	1	1/8	0.9	10J250	1/16	D1	JA	1/2	1	1/8	1.1
2.65	2.68	6J265	7/16	D1	JA	1/8	1	1/8	1.0	10J265	1/16	D1	JA	1/2	1	1/8	1.4
2.80	2.83	6J280	7/16	D1	JA	1/8	1	1/8	1.1	10J280	1/16	D1	JA	1/2	1	1/8	1.2
3.00	3.03	6J300	7/16	D1	JA	1/8	1	1/8	1.3	10J300	1/16	D1	JA	1/2	1	1/8	1.8
3.15	3.18	6J315	7/16	D1	JA	1/8	1	1/8	1.4	10J315	1/16	D1	JA	1/2	1	1/8	1.6
3.35	3.38	6J335	7/16	D1	JA	1/8	1	1/8	1.5	10J335	3/8	D1	SH	5/16	1 1/4	1/8	2.1
4.50	4.53	6J450	11/16	D1	SH	0	1 1/4	1/16	3.5	10J450	3/8	D1	SH	5/16	1 1/4	3/16	3.5
6.00	6.03	6J600	11/16	D1	SH	0	1 1/4	1/16	4.3	10J600	3/8	D2	SH	11/32	1 1/4	1/8	5.0
8.00	8.03	6J800	11/16	D2	SH	0	1 1/4	1/8	5.7	10J800	3/8	D2	SH	11/32	1 1/4	1/8	5.0
10.60	10.63	6J1060	11/16	D3	SH	0	1 1/4	1/8	6.9	10J1060	11/16	C3	SK	1/4	1 7/8	1/8	13.2
14.00	14.03	6J1400	15/16	C3	SK	0	1 7/8	1/4	15.6	10J1400	11/16	C3	SK	1/4	1 7/8	1/4	19.2
19.00	19.03	6J1900	15/16	C3	SK	0	1 7/8	1/4	23.7	10J1900	11/16	C3	SK	1/4	1 7/8	1/4	26.3

O.D.	P.D.	PRODUCT NO.	16 GROOVES						Wt. (lbs.)
			F = 1-21/32						
			E*	TYPE	BUSH	K	L	M	
2.50	2.53	16J250	21/32	E1	JA	15/32	1	0	1.5
2.65	2.68	16J265	0	D1	JA	1/2	1	11/16	1.4
2.80	2.83	16J280	1/16	D1	JA	1/2	1	3/4	1.5
3.00	3.03	16J300	11/16	D1	SH	0	1 1/4	1	2.6
3.15	3.18	16J315	11/16	D1	SH	0	1 1/4	1	2.7
3.35	3.38	16J335	3/16	A1	SH	7/8	1 1/4	1/8	2.4
4.50	4.53	16J450	3/16	A1	SH	7/8	1 1/4	1/8	4.0
6.00	6.03	16J600	3/16	A2	SH	15/16	1 1/4	1/8	4.6
8.00	8.03	16J800	5/8	D3	SK	15/16	1 7/8	3/8	12.4

\*"E" Dimension varies according to shaft tolerance.

Weights for all Sure-Grip bushed items are approximate and include the bushing.

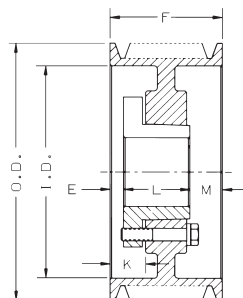

Type A

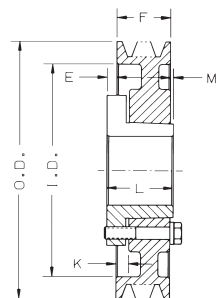

Type C

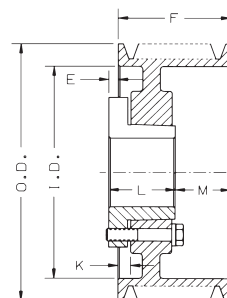

Type D

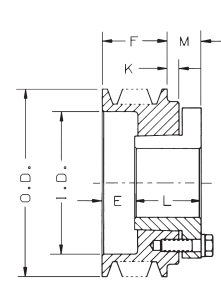

Type E

Contact TB Wood's Incorporated for quotes on other belt sections and configurations.

# Poly-V Belting Lengths

The Following Belts Are NOT Stocked, But Are Readily Available

"J" CROSS-SECTION	
PRODUCT NUMBER	OUTSIDE LENGTH
180J	18.5
190J	19.5
200J	20.5
220J	22.5
240J	24.5
260J	26.5
280J	28.5
290J	29.5
300J	30.5
310J	31.5
320J	32.5
340J	34.5
360J	36.5
380J	38.5
400J	40.5
410J	41.5
420J	42.5
430J	43.5
460J	46.5
490J	49.5
520J	52.5
550J	55.5
580J	58.5
610J	61.5
650J	65.5
690J	69.5
730J	73.5
770J	77.5
820J	82.5
840J	84.5
870J	87.5
890J	89.5
920J	92.5

"L" CROSS-SECTION	
PRODUCT NUMBER	OUTSIDE LENGTH
500L	51.0
540L	55.0
560L	57.0
595L	60.5
615L	62.5
635L	64.5
655L	66.5
695L	70.5
725L	73.5
765L	77.5
780L	79.0
795L	80.5
815L	82.5
840L	85.0
865L	87.5
915L	92.5
975L	98.5
990L	100.0
1065L	107.5
1120L	113.0
1150L	116.0
1215L	122.5
1230L	124.0
1295L	130.5
1310L	132.0
1455L	146.5

"M" CROSS-SECTION	
PRODUCT NUMBER	OUTSIDE LENGTH
900M	92.0
940M	96.0
990M	101.0
1060M	108.0
1150M	117.0
1185M	120.0
1230M	125.0
1310M	133.0
1390M	141.0
1470M	149.0
1550M	157.0
1610M	163.0
1650M	167.0
1760M	178.0
1830M	185.0
1980M	200.0
2130M	215.0
2410M	243.0
2560M	258.0
2710M	273.0
3010M	303.0
3310M	333.0
3610M	363.0

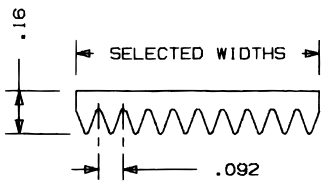
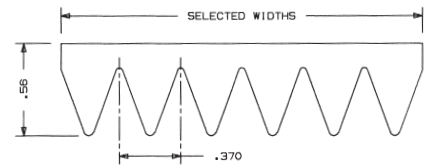
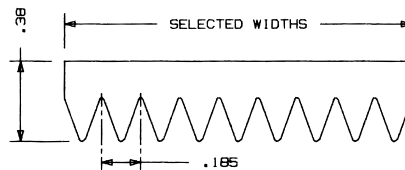

		NUMBER OF RIBS - BELT WIDTH								
		4	6	8	10	12	14	16	18	20
"J"		3/8	9/16	NS	15/16	NS	NS	1 1/2	NS	NS
"L"		NS	1 1/8	1 1/2	1 7/8	2 1/4	2 5/8	3	3 3/8	3 3/4
"M"		NS	1 1/4	3	3 3/4	4 1/2	5 1/4	6 1/2	6 3/4	7 1/2